

男子団体(35)

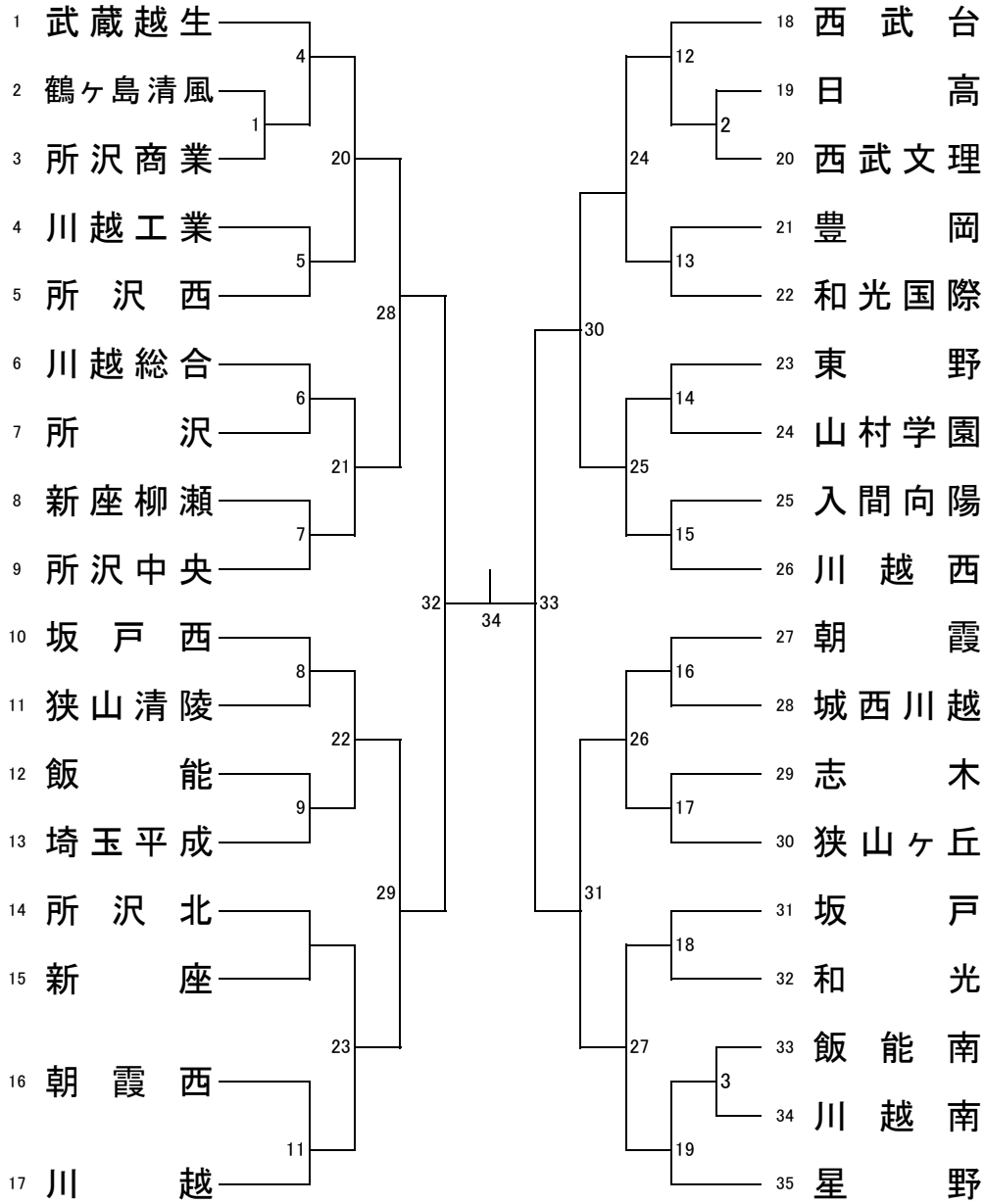

3位決定戦

5位決定戦

7位決定戦

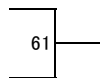
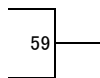

リーグ戦参加決定戦

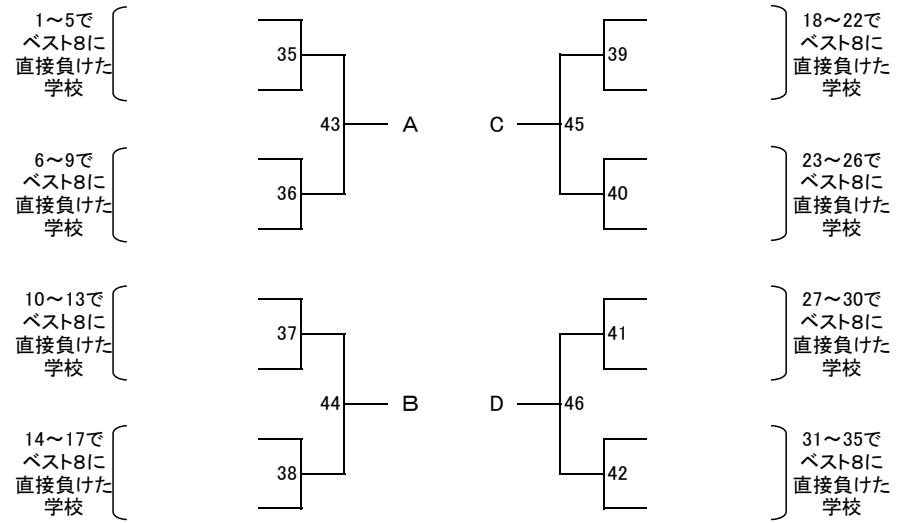

県大会出場決定リーグ戦

					勝敗	順位
1~9でB8		51	49	47		
10~17でB8			48	50		
A				52		
B						

					勝敗	順位
18~26でB8		57	55	53		
27~35でB8			54	56		
C				58		
D						